

K-980W

Pet-immune Wireless PIR Motion Detector



Installation Instructions

1. FEATURES

- Uses TSI™ (Target Specific Imaging) technology for distinction between humans and pets
- Immune to pets weighing up to 36 kg (80 lb)
- Integral swivel bracket for wall or ceiling installation
- Sealed chamber protects the optical system
- On-board CE and FCC approved transmitter
- Programmable pulse counter (1, 2, 3 or 5 pulses)
- 9 Volt battery powered, with unique energy saving circuitry
- Extremely-low current consumption – 0.013 mA
- Automatically inhibited after detecting motion; reverts to the ready state if no motion is detected for 2 minutes.
- A TEST/NORMAL selector eliminates the 2-minute inhibit period and sets the pulse counter to 1-pulse during walk testing.
- Automatic transmission of low-battery and tamper alerts
- Three-position vertical adjustment
- White light protection
- Programmable 8-bit system code and 4-bit channel code
- Surface and corner mounting

- Rejects RF interference up to 1000 MHz
- Elegantly styled, sturdy case
- Keyhole-shaped slot for easy removal of PCB

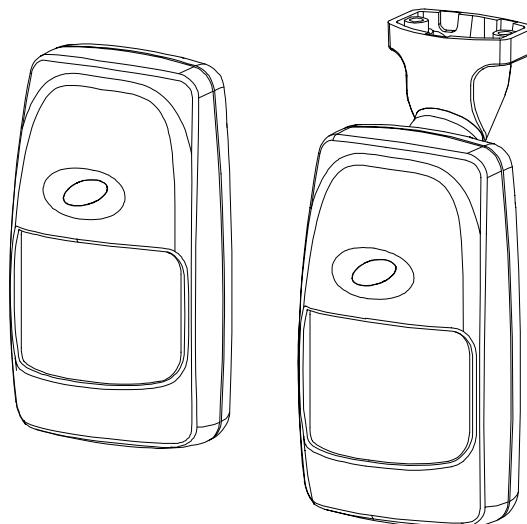

Figure 1. The K-980W Wireless Detector

2. SPECIFICATIONS

OPTICAL

Max. Coverage Range: 9 x 9 m (30 x 30 ft) / 90°

Pet Immunity: Immune to pets weighing up to 36 kg (80 lb) under optimal environmental conditions.

Vertical Adjustment: 3-position adjustment scale: 1.8 m (6 ft), 2.1 m (7 ft) and 2.4 m (8 ft).

ELECTRICAL

Voltage: 9 Volt alkaline or lithium battery.

Standby Current: 0.013 mA.

LED: Walk Test & transmission.

Detector: Dual-element low-noise pyroelectric sensor.

Pulse Counter: Programmable to 1, 2, 3 or 5 pulses with walk-test override.

Inhibit Timer: re-enables the unit about 2 minutes after alarm, if no further motion is detected.

WIRELESS

Frequency (MHz): 315, 304, 404, 418, 433.92 or other frequencies according to local requirements.

Frequency Allocations for Wireless Devices in European (EU) Countries

- 433.92 MHz has no restriction in any EU member state.
- 418 MHz is allowed in the UK only.
- 315 MHz is not allowed in any EU member state

Alarm Transmission Duration: 2 seconds.

Encoding: 8-bit digital word, 256 combinations, pulse width modulation.

Channels: 4 channels, switch selectable.

Battery Test: Automatic transmission of "Code 0" at 2-minute intervals if the battery voltage drops below 7 V.

Tamper Alert: Transmission of the "Channel 2" code at 2-minute intervals, until the tamper switch is restored.

ENVIRONMENTAL

Operating Temperature: -10°C to 50°C (14°F to 122°F).

Storage Temperature: -20° to 60°C (-4°F to 140°F).

RFI Protection: Greater than 30 V/m up to 1000 MHz.

Note: The temperature range may be reduced due to battery characteristics.

Compliance with Standards: Meets FCC Part 15 requirements;

This device complies with the essential requirements and provisions of Directive 1999/5/EC of the European Parliament and of the Council of 9 March 1999 on radio and telecommunications terminal equipment.

MOUNTING

Height: 1.8 to 2.4 m (6 to 8 ft)

Installation Options: Surface or corner (without bracket); surface or ceiling (with bracket).

Bracket Adjustment: 20° downward (only in non-pet immune applications), 20° left and right.

PHYSICAL

Dimensions (H x W x D): 117 x 65 x 47 mm (4-5/8 x 2-9/16 x 1-7/8 in.).

Weight: 92 g (3.25 oz) without bracket, 107 g (3.8 oz) with bracket.

Color: White

PATENTS

U.S. Patent No. 6,211,522

3. INSTALLATION

3.1 Installation Hints



Important! Under optimal environmental conditions, the detector is immune to animals weighing up to 36 kg (80 lb) that move on the floor or climb on furniture, as long as this activity takes place below 1 m (3 ft). Above 1 m (3 ft), the detector is immune to pets weighing 18 kg (40 lb), but the pet immunity will decrease as the pet gets closer to the detector. It is therefore recommended to select a mounting location that minimizes potential close proximity of animals.

When installing keep in mind the advice given in Figure 2 below:

<p>Do not aim at heat sources</p>	<p>Mount on solid, stable surfaces</p>
<p>Do not expose to air drafts</p>	<p>Do not install outdoors</p>
<p>Prevent direct sunlight from reaching the detector</p>	<p>Keep wiring away from electrical power cables</p>
<p>Do not install behind partitions</p>	<p>1.8 to 2.4 meters (6 to 8 ft)</p>

Figure 2. Installation Hints

3.2 Mounting without Swivel Bracket

A. Remove the front cover as shown in Figure 3.

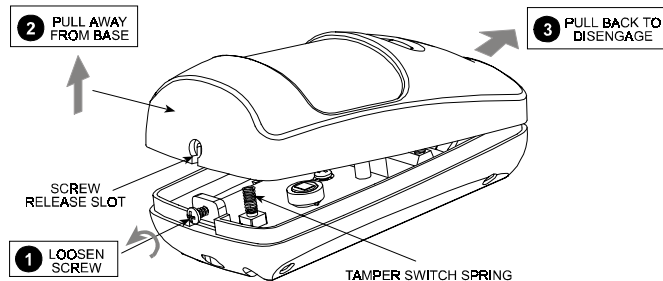

Figure 3. Cover Removal

- B. Loosen the vertical adjustment screw, slide the PCB down and remove it via the "keyhole" (see Figure 4).
- C. Pull the PCB straight out and put it aside until required again.
- D. Refer to Figure 4 and punch out the mounting knockouts at the rear wall of the base (for surface mounting) or mounting

knockouts at the angled sides of the base (for corner mounting).

- E. Hold the base against the wall at the selected installation location and mark the points for drilling.
- F. Drill the holes and insert the plastic anchors supplied (if necessary).
- G. Return the PCB to its place: align the "keyhole" with the head of the vertical adjustment screw, press the PCB against the base, slide the PCB up and adjust it as explained in Para. 3.8.

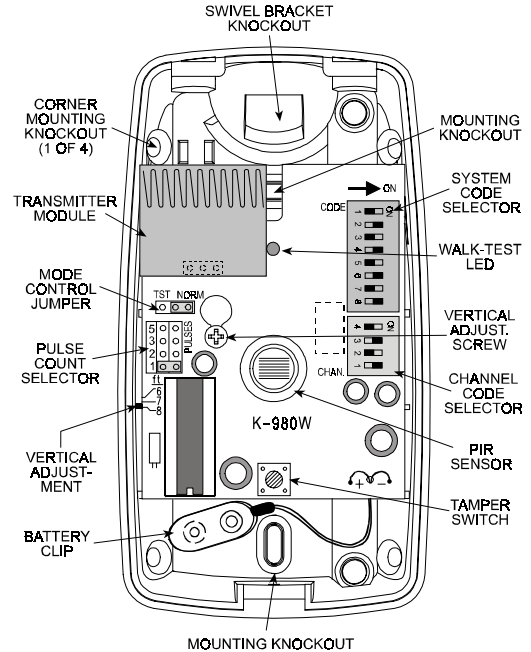

Figure 4. Inside View

3.3 Mounting with Swivel Bracket

- A. Remove the front cover as shown in Figure 3.
- B. Remove the PCB and put it temporarily aside.
- C. Punch out the large knockout in the round bulge at the top part of the base (see Figure 5)

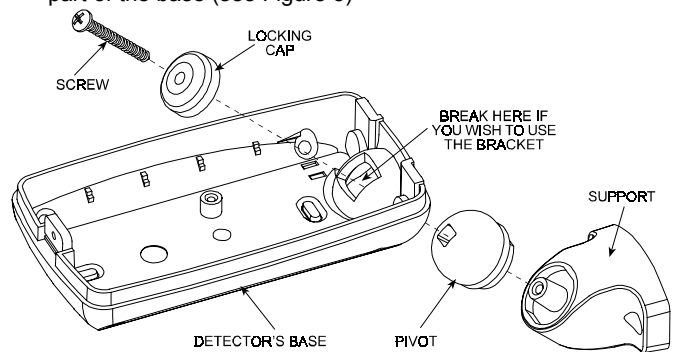

Figure 5. Attaching the Bracket

- D. Assemble the bracket as shown in Figure 5.
- E. Rotate the bracket to the desired position (see Figure 6) but do not yet tighten the screw fully.

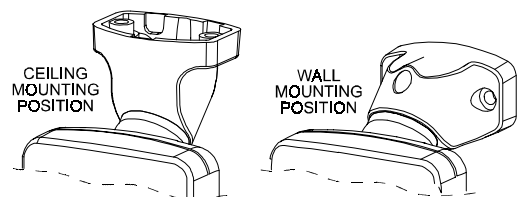

Figure 6. Wall and Ceiling Positions of Bracket

- F. Press the bracket against the mounting surface and mark the points for drilling. Drill out the holes and insert plastic anchors.
- G. Attach the bracket to the mounting surface using the two screws supplied.
- H. Swivel the detector horizontally to face the desired direction, but **do not tilt it if this is a pet immune application**. However, if pets are not present it is advisable to tilt the detector as much as 20° down. Figure 7 shows the tilt/swivel possibilities.

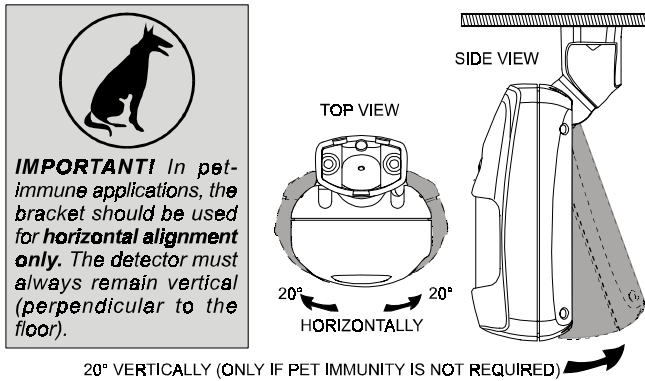

Figure 7. Tilt/Swivel Limits

- I. Once the detector is directed as desired, tighten the bracket assembly screw well, to prevent any further change of position.

3.4 Battery Installation

The K-980W is powered by a 9-volt alkaline or lithium battery. Remove the detector's front cover, snap the battery clip onto the battery and place the battery in its place (below the printed circuit board). Before testing, allow 10 minutes for the detector to stabilize (the LED may light during this time).

Warning! For proper operation, use only alkaline or lithium type batteries.

3.5 System Code Selection

The code selector consists of an 8-key DIP switch (see Figure 8). Each key is set to either ON or OFF position to create a unique digital system code combination (256 possibilities).

Select a digital code that matches the one selected on the companion receiver.

All wireless detectors and the receiver used in the alarm system must be set to the same digital system code.

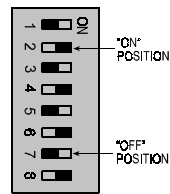

Figure 8. System Code Selector

CAUTION: The code combination 2, 4, 5, 6, 7 ON / 1, 3, 8 OFF is a factory setting that must be avoided. Also avoid codes such as all keys ON, all keys OFF or alternating ON-OFF settings.

3.6 Channel Code Selection

The Visonic Ltd. wireless security systems have a multi-channel capability. Each wireless K-980W detector can be set to transmit one of 4 different channel codes. Each channel code activates a particular output circuit of the companion receiver.

This feature is very useful for zoning purposes - activation of different type of zones at the control panel.

The channel selector consists of a 4-key DIP switch (see Figure 9). The channel code is selected by setting the key with the desired channel number to ON.

If there is a low battery condition, a LOW BATTERY alert code (code "0") will be automatically transmitted once every 2 minutes, regardless of the channel selector setting. Code "0" causes receivers equipped with a buzzer output to activate the buzzer. Setting the 4 channel keys to OFF and initiating a transmission is a way to check whether code "0" works.

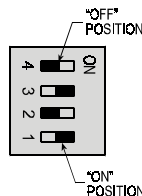

Figure 9. Channel Code Selector

Upon activation of the detector's tamper switch (by removing the front cover), channel "2" code will be automatically transmitted once every 2 minutes, regardless of the channel selector setting.

Caution: Do not select channel 2 as the normal alarm channel, because this will cause alarm and tamper events to have the same channel code.

3.7 Setting the Pulse Counter

The location of the pulse count selector is indicated in Figure 4. Refer to Figure 10 below and mount the jumper as desired.

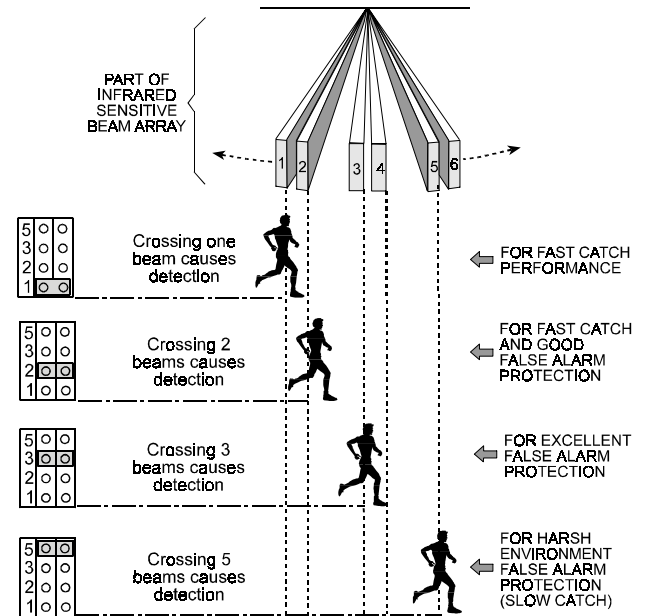

Figure 10. Pulse Counter Setting Options

3.8 Vertical Adjustment

A. Pet-Immune Applications

To maintain maximum coverage range and pet immunity, the vertical adjustment scale must be adjusted in accordance with the actual mounting height (refer to Figure 11). Loosen the vertical adjustment screw and slide the printed circuit board up or down until the pointer shows the actual mounting height on the scale. When done, re-tighten the screw well.

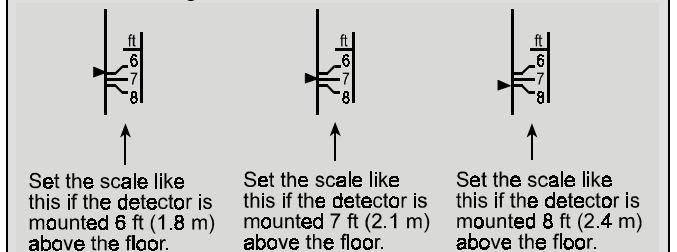

Figure 11. Vertical Adjustment



B. Pet-Free Locations

To obtain the best coverage possible where no pets are present, mount the detector with the integral bracket at any desired height between 1.8 m (6 ft) and 2.4 m (8 ft). Then set the vertical adjustment scale to the 2.4 m (8 ft) position and tilt the detector 20° down.

3.9 Setting the TST/NORM Jumper

Since battery saving is of utmost importance in normal use of the detector unit, an automatic timer inhibits the detector for approximately 2 minutes after each transmission. During this period, the transmitter cannot be triggered again by subsequent motion within the protected area. The detector is automatically rearmed 2 minutes after the last motion was detected.

For rapid walk testing of the coverage pattern, you must eliminate the 2 minute inhibit interval between successive alarms. The NORM/TEST selector, when set to TEST, overrides the 2-minute rearm timer, and also sets the pulse counter to 1 PULSE. Remember that in the TEST mode, tamper and low battery alerts will be transmitted at 1/2 second intervals instead of the usual 2-minute intervals. When the selector is reset to NORM, the rearm timer reverts to normal operation.

	TEST Position Setting the jumper as shown overrides the rearm timer and the pulse counter, allowing you to walk test the detector rapidly.
	NORMAL Position: Setting the jumper as shown re-enables the 2-minute rearm timer and the pulse counter.

3.10 Final Testing

- A. Snap the battery clip onto the 9 Volt alkaline or lithium battery and allow ten minutes for the unit to stabilize before testing.
- B. Adjust the vertical calibration position per Para. 3.8.
- C. Set the Normal/Test selector to TEST.
- D. Put the cover back in place.
- E. Walk-test the entire protected area by walking slowly across it, observing the LED. The LED lights whenever you cross a

protective beam. Allow the unit to re-stabilize for 5 seconds after each test.

F. In pet immune applications, continue the test by sending the house pet into the protected area. Make sure it does not trigger the detector by moving across the protected area and by climbing on furniture within that area.

G. Remove the cover and set the pulse counter as required for the particular application.

H. Set the NORMAL/TEST selector to NORM, mount the cover and wait 5 minutes outside the coverage area. Then re-enter the coverage area and verify that the LED lights (response will be immediate only if the pulse counter is set to **1 pulse**).

If you continue moving within the detector's field of view, the LED will turn OFF and the unit will remain disabled as long as movement continues, due to the 2-minute battery saving rearm timer. The unit will be rearmed provided that no motion is detected for approximately 2 minutes, and will again be ready to detect and signal.

CAUTION: *The range and coverage area of the unit should be checked at least once a year. To assure proper continuous function, the end user should be instructed to perform a walk test at the far end of the area to assure an alarm signal prior to each time the alarm system is armed.*

4. LIMITATIONS AND WARNINGS

Visonic Ltd. wireless systems are very reliable and are tested to high standards. However, due to their low transmitting power (required by FCC and other regulatory authorities), there are some limitations to be considered:

- A. Receivers may be blocked by radio signals on or near their operating frequencies, regardless of the code selected.
- B. Receivers can only respond to one transmitted signal at a time.
- C. Wireless equipment should be tested regularly (at least once a week) to determine if there are sources of interference and to protect against faults.

The 315 MHz version of this device complies with Part 15 of the FCC Rules. Operation is subject to the following two conditions: (1) This device may not cause harmful interference, and (2) This device must accept any interference received, including interference that may cause undesired operation.

WARNING! *Changes or modifications to this unit not expressly approved by the party responsible for compliance could void the user's authority to operate the equipment.*

The digital circuit of this device has been tested and found to comply with the limits for a Class B digital device, pursuant to Part 15 of the FCC Rules. These limits are designed to provide reasonable protection against harmful interference in residential installations. This equipment generates, uses and can radiate radio frequency energy and, if not installed and used in accordance with the instructions, may cause harmful interference to radio and television reception. However, there is no guarantee that interference will not occur in a particular installation. If this device does cause such interference, which can be verified by turning the device off and on, the user is encouraged to eliminate the interference by one or more of the following measures:

- Re-orient or re-locate the receiving antenna.
- Increase the distance between the device and the receiver.
- Connect the device to an outlet on a circuit different from the one which supplies power to the receiver.
- Consult the dealer or an experienced radio/TV technician.

WARRANTY

Visonic Ltd. and/or its subsidiaries and its affiliates ("the Manufacturer") warrants its products hereinafter referred to as "the Product" or "Products" to be in conformance with its own plans and specifications and to be free of defects in materials and workmanship under normal use and service for a period of twelve months from the date of shipment by the Manufacturer. The Manufacturer's obligations shall be limited within the warranty period, at its option, to repair or replace the product or any part thereof. The Manufacturer shall not be responsible for dismantling and/or reinstallation charges. To exercise the warranty the product must be returned to the Manufacturer freight prepaid and insured.

This warranty does not apply in the following cases: improper installation, misuse, failure to follow installation and operating instructions, alteration, abuse, accident or tampering, and repair by anyone other than the Manufacturer.

This warranty is exclusive and expressly in lieu of all other warranties, obligations or liabilities, whether written, oral, express or implied, including any warranty of merchantability or fitness for a particular purpose, or otherwise. In no case shall the Manufacturer be liable to anyone for any consequential or incidental damages for breach of this warranty or any other warranties whatsoever, as aforesaid.

This warranty shall not be modified, varied or extended, and the Manufacturer does not authorize any person to act on its behalf in the modification, variation or extension of this warranty. This warranty shall apply to the Product only. All products, accessories or attachments of others used in conjunction with the Product, including batteries, shall be covered solely by their own warranty, if any. The Manufacturer shall not be liable for any damage or loss whatsoever, whether directly, indirectly, incidentally, consequentially or otherwise, caused by the malfunction of the Product due to products, accessories, or attachments of others, including batteries, used in conjunction with the Products.

The Manufacturer does not represent that its Product may not be compromised and/or circumvented, or that the Product will prevent any death, personal and/or bodily injury and/or damage to property resulting from burglary, robbery, fire or otherwise, or that the Product will in all cases provide adequate warning or protection. User understands that a properly installed and maintained alarm may only reduce the risk of events such as burglary, robbery, and fire without warning, but it is not insurance or a guarantee that such will not occur or that there will be no death, personal damage and/or damage to property as a result.

The Manufacturer shall have no liability for any death, personal and/or bodily injury and/or damage to property or other loss whether direct, indirect, incidental, consequential or otherwise, based on a claim that the Product failed to function. However, if the Manufacturer is held liable, whether directly or indirectly, for any loss or damage arising under this limited warranty or otherwise, regardless of cause or origin, the Manufacturer's maximum liability shall not in any case exceed the purchase price of the Product, which shall be fixed as liquidated damages and not as a penalty, and shall be the complete and exclusive remedy against the Manufacturer.

Warning: *The user should follow the installation and operation instructions and among other things test the Product and the whole system at least once a week. For various reasons, including, but not limited to, changes in environmental conditions, electric or electronic disruptions and tampering, the Product may not perform as expected. The user is advised to take all necessary precautions for his/her safety and the protection of his/her property.*

6/91



VISONIC LTD. (ISRAEL): P.O.B 22020 TEL-AVIV 61220 ISRAEL. PHONE: (972-3) 645-6789, FAX: (972-3) 645-6788
 VISONIC INC. (U.S.A.): 10 NORTHWOOD DRIVE, BLOOMFIELD CT. 06002-1911. PHONE: (860) 243-0833, (800) 223-0020 FAX: (860) 242-8094
 VISONIC LTD. (UK): FRASER ROAD, PRIORY BUSINESS PARK, BEDFORD MK44 3WH. PHONE: (0870) 7300800 FAX: (0870) 7300801
 INTERNET: www.visonic.com

©VISONIC LTD. 2001 K-980W DE3582- (REV. 2, 5/01)



MADE IN ISRAEL